

Инструкция по сборке Instructions for assembling furniture Instrukcja montażu mebli

Набор модульной мебели
Collection «TIFFANY»
Kolekcja mebli

«TIFFANY»

Шкаф 5DG2S Z
Cupboard 5DG2S Z
Szafa 5DG2S Z

AH-024.58.00.00

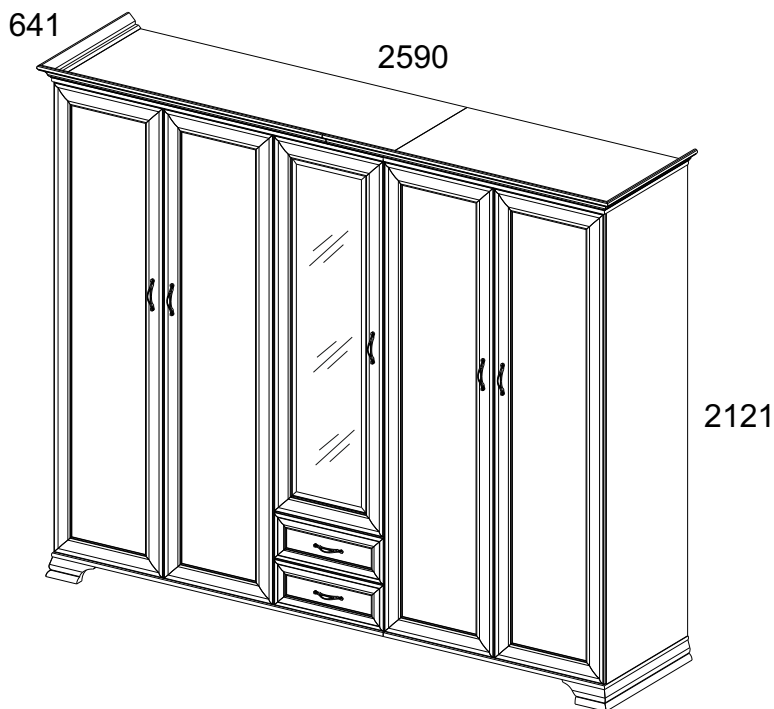

Дата изготовления
Production date
Data produkcji

Штамп ОТК
Stamp of Quality Department
Pieczęć Działu Jakości

ИООО « АНРЭКС »

Республика Беларусь, 224004
г.Брест, ул. Катин Бор, 119
тел/факс (+375162) 29-74-68



ЕАЭС №BY/112 11.01. TP025 018 06065

от 27.01.2021
по 26.01.2026

Инструкция по эксплуатации.

Качество и комплектность изделия рекомендуется проверять в магазине при покупке в распакованном виде. Сборка изделия должна производиться в порядке, изложенном в настоящей инструкции. В процессе эксплуатации изделий необходимо периодически затягивать ослабленные винтовые соединения. В случае необходимости перемещения изделия по квартире перед его перестановкой, необходимо полностью освободить его от груза (матраца). Во избежание поломки имеющихся опор передвижение производить приподнимая изделие над уровнем пола. Запрещён прямой контакт с водой. Удаление пыли с изделий следует производить слегка влажной мягкой салфеткой. Во избежание коробления деталей и изменения цвета изделия следует избегать установки мебели на прямых солнечных лучах.

При эксплуатации изделий набора **ЗАПРЕЩАЕТСЯ:**

- устанавливать мебель вблизи отопительных приборов и вплотную к сырým стенам и в помещениях с относительной влажностью более 70%;
- температура нагрева элементов мебели не должна превышать +40 °С.
- в процессе сборки и эксплуатации изделий набора становиться ногами на горизонтальные щиты и витрины;
- применять химические чистящие средства для уборки мебели;

Гарантии изготовителя.

1. Гарантийный срок эксплуатации изделия - 24 месяца со дня продажи магазином. В период гарантийного срока изготовитель гарантирует ремонт изделий или их замену, если потребителем не нарушены правила эксплуатации.
2. Претензии предъявляются потребителем непосредственно в торгующую организацию, в которой была приобретена мебель, предъявив настоящую "Инструкцию по сборке" и копию товарного чека.
3. Изделие **Шкаф 5DG2S Z**, входящее в состав набора модульной мебели «**TIFFANY**», соответствует требованиям ГОСТ 16371-2014, ТР ТС 025/2012.
4. Срок службы мебели - 5 лет.
5. Предприятие-изготовитель оставляет за собой право вносить изменения в конструкцию изделия, не ухудшая его конструктивные и эксплуатационные характеристики.
6. Для сборки изделий рекомендуется привлекать квалифицированных специалистов.

Запах.

От новой мебели может исходить запах материалов, из которых она изготовлена. Запах может сохраняться в течение трёх недель с момента сборки. Для снижения интенсивности запаха рекомендуется:

-для мягкой мебели - пропылесосить изделие и проветрить помещение.

Повторять 3-4 раза в день.

-для корпусной мебели – протирать тканью, смоченной мягким моющим средством, вытирать чистой сухой тканью и проветривать помещение, предварительно открывая все двери и ящики изделия.

Повторять 3-4 раза в день.

Важно! Сохраните, пожалуйста, инструкцию в случае повторной сборки мебели или рекламации. В случае составления рекламации пользуйтесь, пожалуйста, обозначением из инструкции сборки.

PL

Przy eksploatacji mebli zabrania się:

- ustawiać meble w pobliżu grzewczych przyrządów i obok wilgotnych ścian, a także w pomieszczeniach ze względną wilgotnością więcej niż 70%;
- temperatura nagrzewania elementów mebli nie może przekraczać +40°C;
- w trakcie montażu i eksploatacji mebli stawać nogami na poziome panele i witryny;
- stosować chemiczne środki czyszczące do sprzątania mebli;
- nie należy narażać na kontakt z wodą.

Gwarancje producenta.

1. Gwarancyjny termin eksploatacji wyrobu - 24 miesiące z dnia sprzedaży. W okresie gwarancyjnego terminu producent gwarantuje naprawę wyrobów lub ich zamianę, jeżeli reguły eksploatacji nie zostały naruszone przez nabywcę.
2. Roszczenia są przekazywane przez nabywcę bezpośrednio do handlującej organizacji, w której były nabyte meble, tylko przy okazaniu danej "Instrukcji montażu" wraz z dokumentem zakupu.
3. Wyrób, **Szafa 5DG2S Z** wchodzące w zestaw mebli **"TIFFANY"**, odpowiada wymaganiom Norm Państwowych 16371-2014, TP TC 025/2012
4. Trwałość użytkowa mebli - 5 lat.
5. Firma-producent pozostawia za sobą prawo do wprowadzania zmian w konstrukcje wyrobów, nie pogarszając ich konstruktywne i eksploatacyjne charakterystyki.
6. Do montażu wyrobów zaleca się skorzystanie z pomocy wykwalifikowanych specjalistów.

Zapach.

Nowe meble mogą wydzielać zapach materiałów, z których są wykonane. Zapach może utrzymywać się do trzech tygodni od momentu montażu. Aby zmniejszyć intensywność zapachu, zaleca się:

- w przypadku mebli tapicerowanych - odkurzyć produkt i przewietrzyć pomieszczenie. Powtarzaj 3-4 razy dziennie.
- dla mebli szafkowych - przetrzyj ściereczką zwilżoną łagodnym detergentem, przetrzyj czystą, suchą ściereczką i przewietrz pomieszczenie, uprzednio otwierając wszystkie drzwi i szuflady produktu. Powtarzaj 3-4 razy dziennie.

Ważne! Proszę zachować instrukcję w razie ponownego montażu mebli lub reklamacji. Podczas składania reklamacji prosimy o korzystanie z oznaczeń z instrukcji.

EN

Instruction manual.

It's advised to check the quality and completeness of the product in the store when buying unpacked. Assembling of the product should be done the way it's described in this manual. While the product is in service loose screw connections should be periodically tightened. If it's necessary to move items around the apartment before moving you should release the product completely from the load (the mattress). To prevent damage to existing supports the product should be lifted before moving. Furniture should not be exposed to contact with water. Dusting the product should be done with a slightly damp soft cloth. To prevent warping of parts and discoloration of products do not install furniture in direct sunlight.

While the product is in service it's PROHIBITED TO:

- Install furniture near heating devices, close to the raw walls and in rooms with a relative humidity of more than 70%;
- heat elements of furniture to the temperature higher +40°C;
- step on the horizontal shields and windows during assembly and use of the products set;
- use chemical cleaners for cleaning furniture;

Manufacturer's warranty.

1. The warranty period of use of the product - 24 months from the date of sale. During the warranty period the manufacturer guarantees repair or replacement of products, if the user has not violated operating rules.
2. Claims should be made by the consumer directly to the trading organization, in which furniture was purchased, presenting the "Instruction manual" and a copy of the sales receipt.
3. The product **Cupboard 5DG2S Z**, which is part of a set of **"TIFFANY"**, meet the requirements of GOST 16371-2014, TR TS 025/2012.
4. The lifetime of furniture - 5 years.
5. The manufacturer reserves the right to make changes in product design, without compromising its design and application requirements.
6. To assemble the products it's recommended to attract qualified personnel.

Smell.

New furniture may emit the smell of the materials from which it is made. The smell can persist for up to three weeks from the time of assembly. To reduce odor intensity, it is recommended:

- for upholstered furniture - vacuum the product and ventilate the room. Repeat 3-4 times a day.
- for cabinet furniture - wipe with a cloth dampened in a mild detergent, wipe with a clean, dry cloth and ventilate the room, previously opening all doors and drawers of the product. Repeat 3-4 times a day.

It is important! Keep the instruction in case of reassembly of furniture or complaint. When making a claim use the notation from the instruction.

| № п/п | Длина мм | Ширина мм | Толщина мм | Кол-во шт. | № пачки |
|-------|-------------|--------------|---------------|---------------|---------|
| 222 | 1945 | 496 | 19 | 4 | 6/8 |
| 401 | 1504 | 600 | 16 | 1 | 3/8 |
| 402 | 1004 | 600 | 16 | 1 | 3/8 |
| 430 | 1504 | 600 | 16 | 1 | 3/8 |
| 431 | 1004 | 600 | 16 | 1 | 1/8 |
| 450 | 968 | 460 | 16 | 2 | 1/8 |
| 451 | 500 | 560 | 16 | 1 | 1/8 |
| 471 | 500 | 560 | 16 | 3 | 1/8 |
| 491 | 1950 | 580 | 16 | 1 | 4/8 |
| 492 | 1950 | 580 | 16 | 1 | 4/8 |
| 535 | 968 | 120 | 16 | 2 | 3/8 |
| 541 | 1950 | 580 | 16 | 1 | 5/8 |
| 542 | 1950 | 580 | 16 | 1 | 5/8 |
| 556 | 496 | 191 | 19 | 2 | 3/8 |
| 576 | 500 | 120 | 16 | 2 | 3/8 |
| 577 | 500 | 120 | 16 | 2 | 3/8 |
| 586 | 442 | 120 | 16 | 2 | 3/8 |
| 626 | 1556 | 496 | 19 | 1 | 7/8 |
| 641 | 210 | 615 | 80 | 1 | 2/8 |
| 642 | 210 | 615 | 80 | 1 | 2/8 |
| 643 | 100 | 80 | 16 | 2 | 3/8 |
| 644 | 100 | 80 | 16 | 2 | 3/8 |
| 651 | 1295 | 80 | 19 | 1 | 8/8 |
| 652 | 1295 | 80 | 19 | 1 | 8/8 |
| 666 | 641 | 80 | 19 | 1 | 8/8 |
| 667 | 641 | 80 | 19 | 1 | 8/8 |
| 681 | 1962 | 508 | 2,5 | 1 | 4/8 |
| 682 | 1962 | 978 | 2,5 | 2 | 5/8 |
| 711 | 472 | 505 | 2,5 | 2 | 1/8 |
| Y2 | 962 | | | 2 | 1/8 |

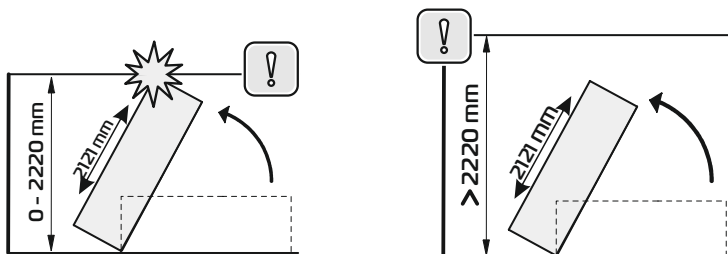

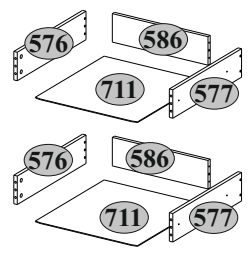
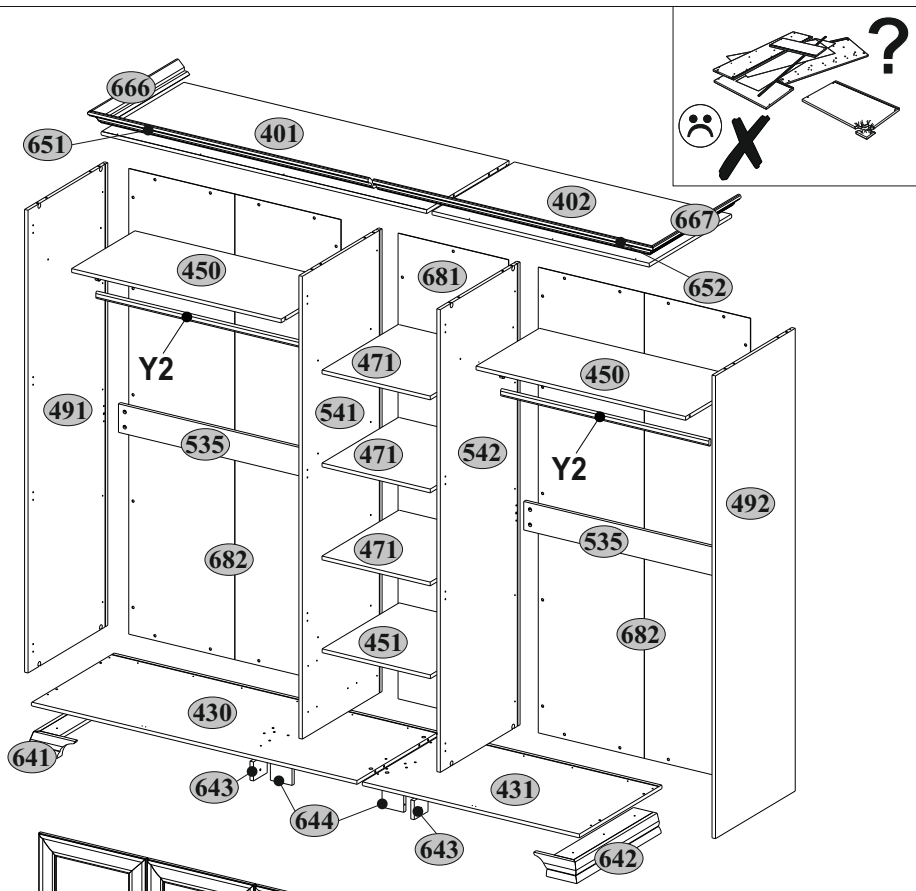

| | | | | | |
|----------------------------|--------------------------------|--------------------------------|---------------------------------|--------------------------------|--|
| | A1.0 5x28 16 | A2 15x13 24 | A7 5,8x17 28 | A8 20x13 28 | |
| | A9 L-47,4 4 | B5 10x50 3 | C1 8x35 28 | C2 8x50 4 | |
| | D1 19 | E1 16 | E4 3 | H18 7 | |
| | I S4 1 | M1 M4x12 4 | M12 M4x25 10 | N1 14 | |
| | P5 12 | Q 1,5x7 10 | Q4 4 | R3 3x20 24 | |
| | R10 4x30 6 | R23 6,3x13 38 | R24 7x50 18 | R27 5,0x13 82 | |
| | R30 2,9x9,5 8 | R39 3,5x25 10 | R102 3,5x16 60 | S5 Ø18 22 | |
| | S8 Ø14 6 | S12 54 | U 90x35x15 3 | U6 1 | |
| U8 120° 2 | Y1 4 | Z13 450 2 | | | |
| | | | | | |

1

A1.0



5x28

4

A7



5,8x17

6

A8



20x13

8

C1



8x35

8

D1



11

P5



6

R23



6,3x13

22

R27



5,0x13

8

R102



3,5x16

4

Y1



Z13



2

450

2

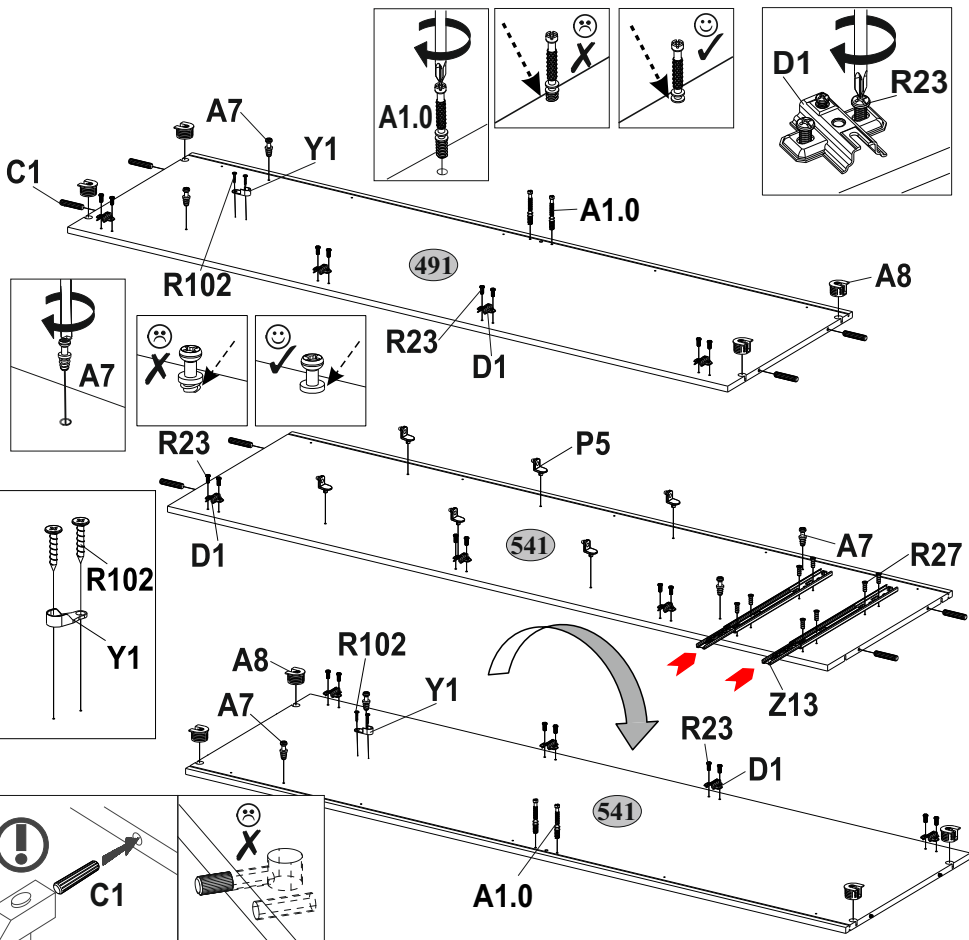
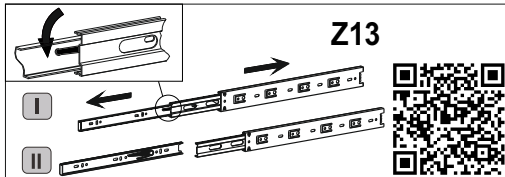
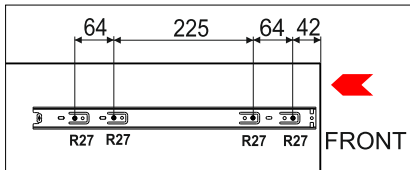

2

A1.0



5x28

4

A7



5,8x17

6

A8



20x13

8

C1



8x35

8

D1



8

P5



6

R23



6,3x13

16

R27



5,0x13

8

R102



3,5x16

4

Y1



Z13

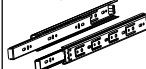

2

450

2

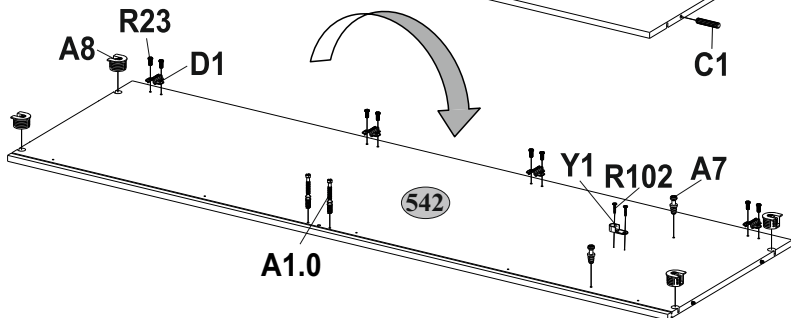
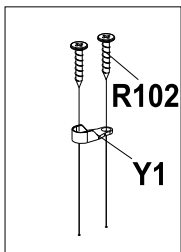
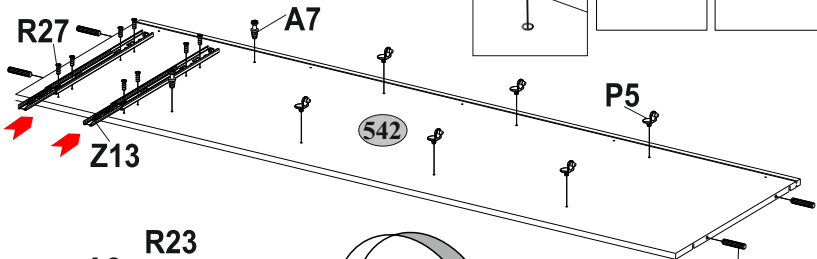
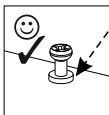
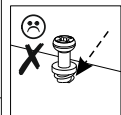
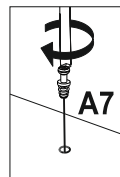
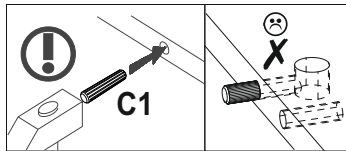
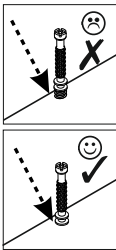
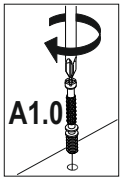
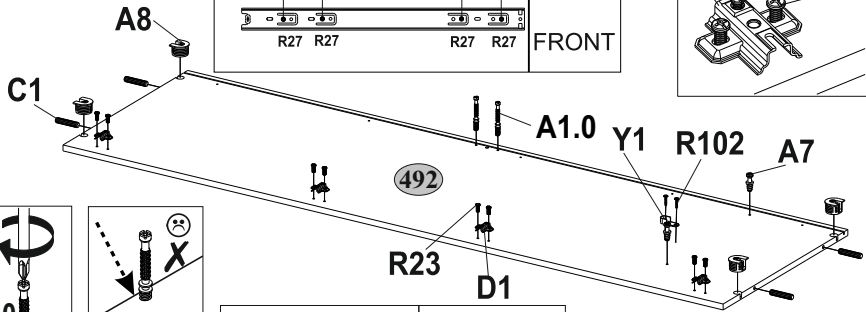
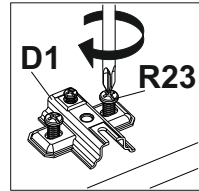
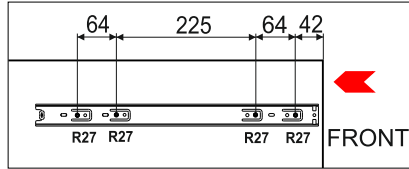

3
x2

A2



15x13

8

A8



20x13

8

C1

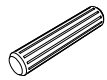

8x35

4

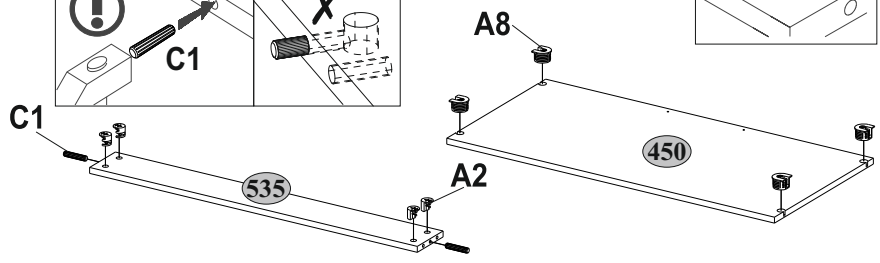
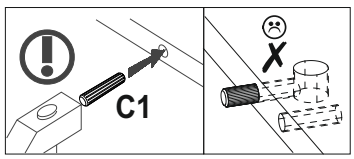
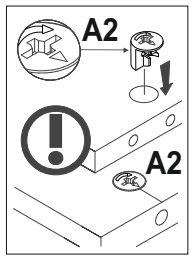

4

A2



15x13

4

A7



5,8x17

A8



20x13

8

C2

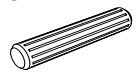

8x50

2

Q4

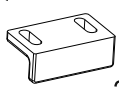

2

R102



3,5x16

4

R102

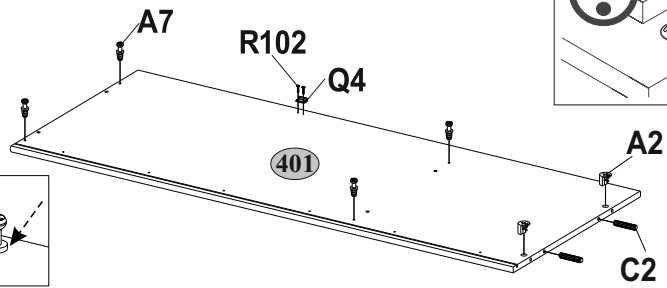
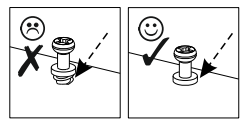
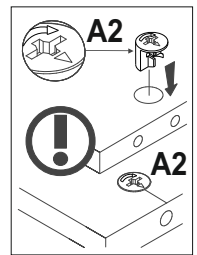
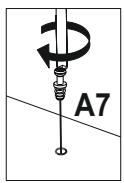
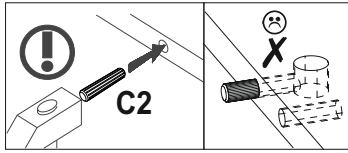
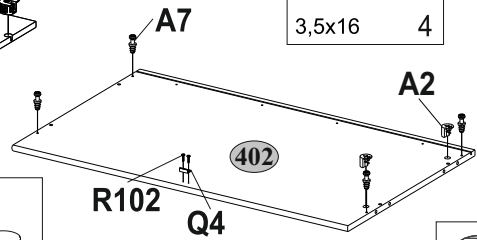
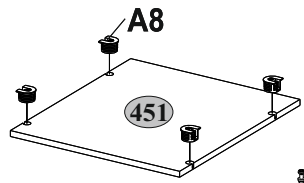
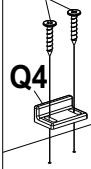

5

- | | | | |
|--------------|----------|------------------|------------------|
| I S4 1 | N1 14 | R10 4x30 6 | R24 7x50 2 |
|--------------|----------|------------------|------------------|

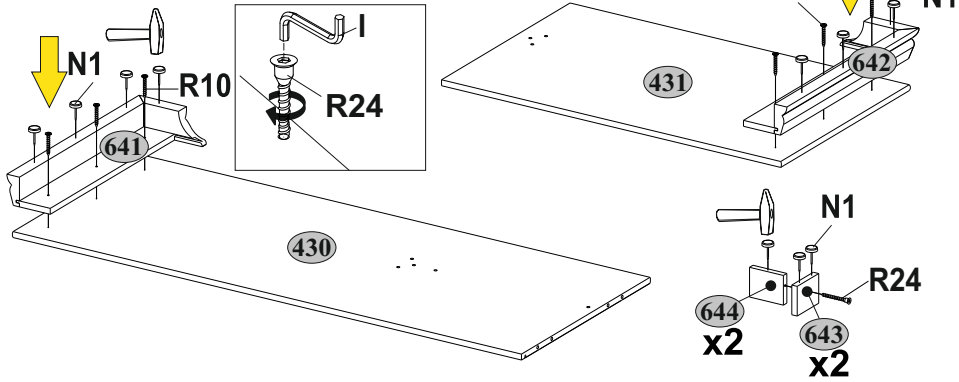

6

- | | | | | |
|------------------|-------------------|-----------------|--------------|---------|
| A2 15x13 4 | A7 5,8x17 8 | C2 8x50 8 | I S4 1 | Q4 2 |
|------------------|-------------------|-----------------|--------------|---------|

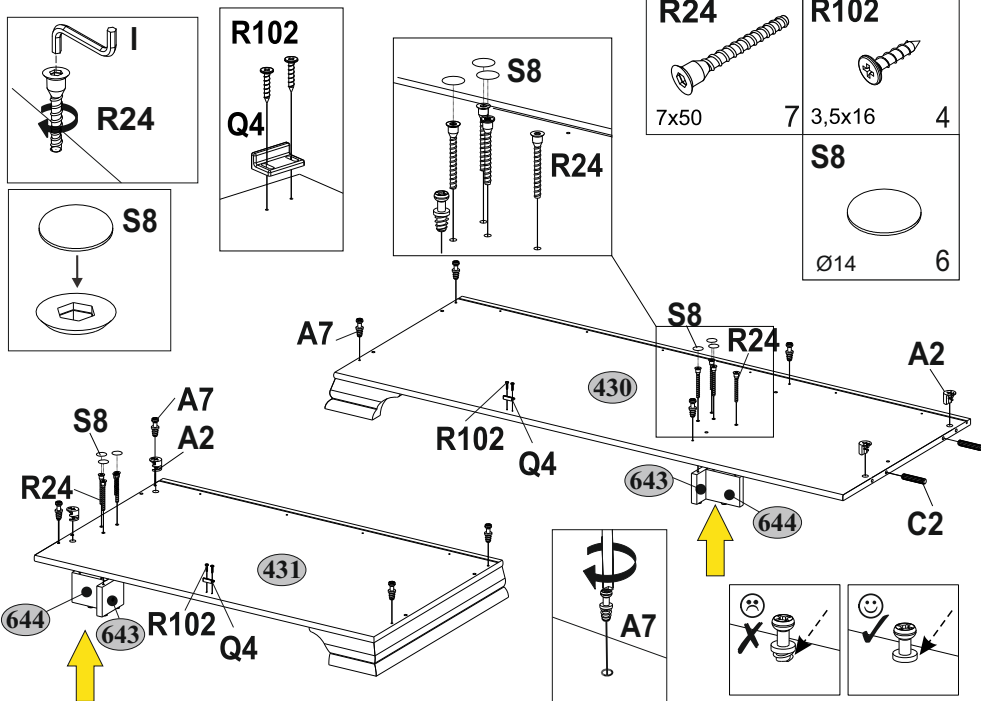

7

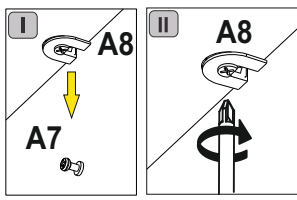
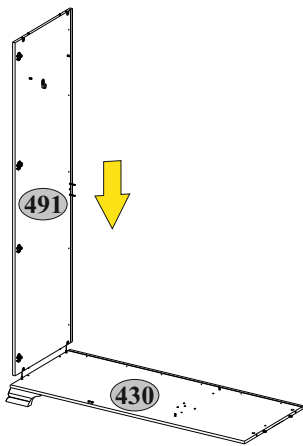

8

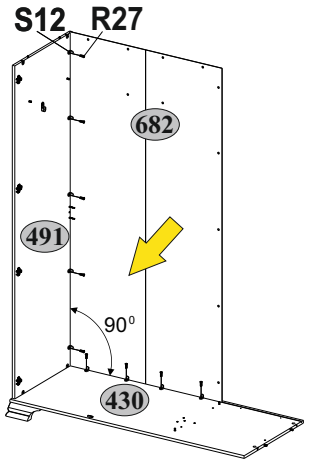
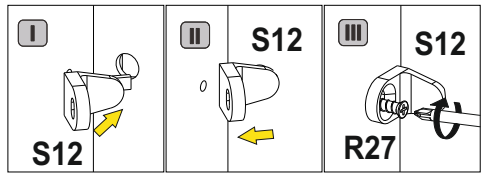
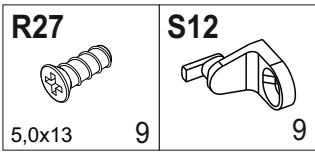

9

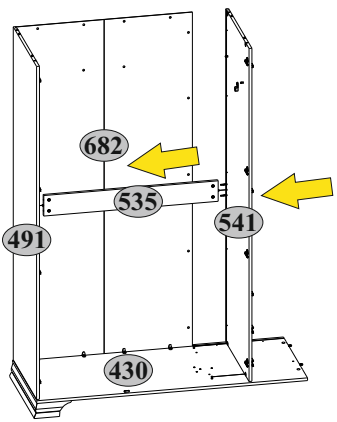
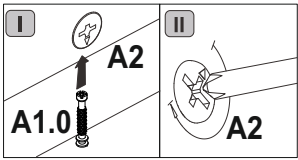
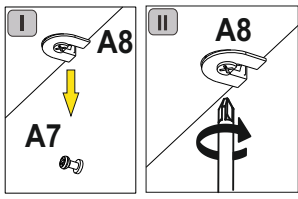

10

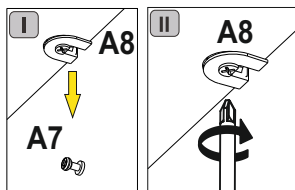
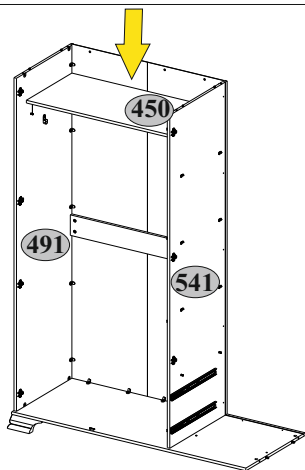

11

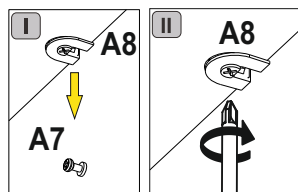
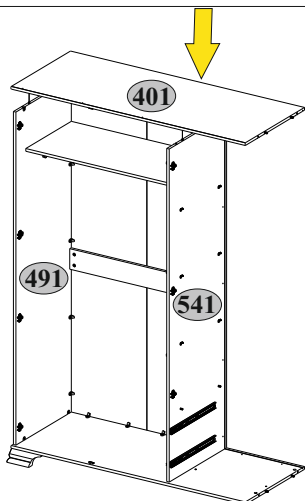

12

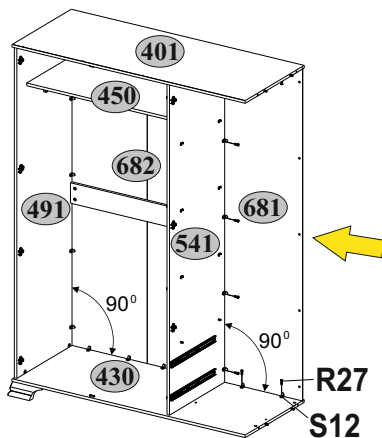
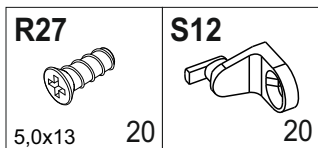

13

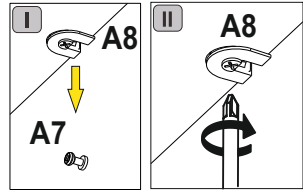
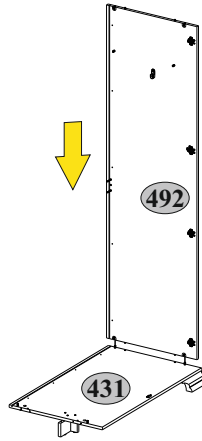

14

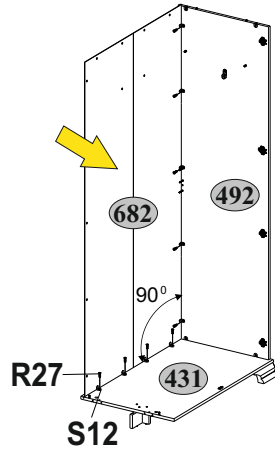
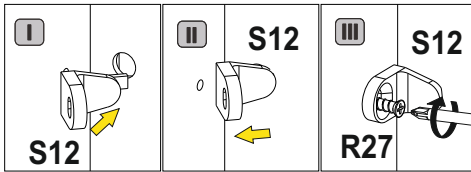
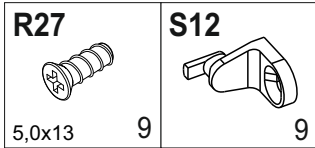

15

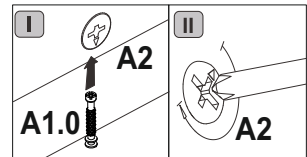
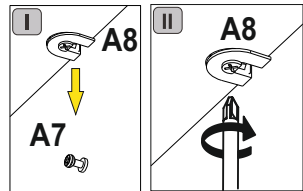
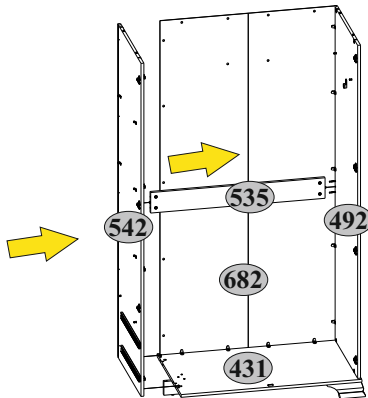

16

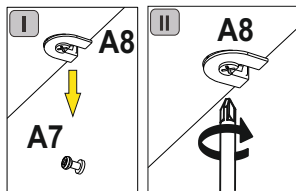
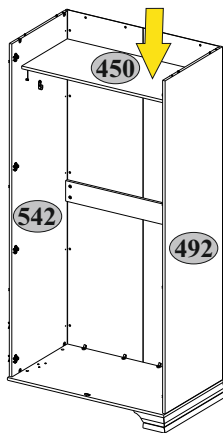

17

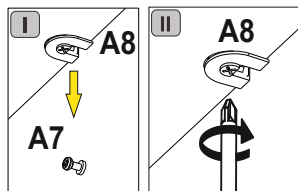
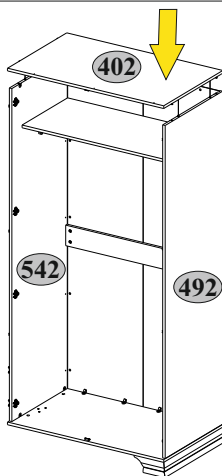

18

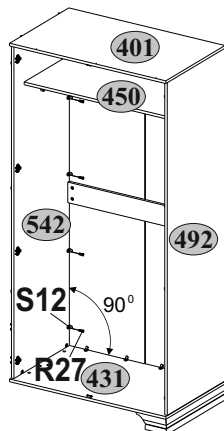
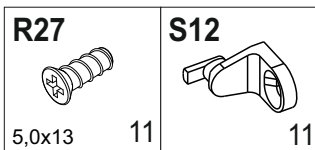

19

R24

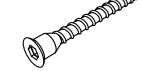

7x50

1

A9

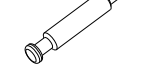

L-47,4

4

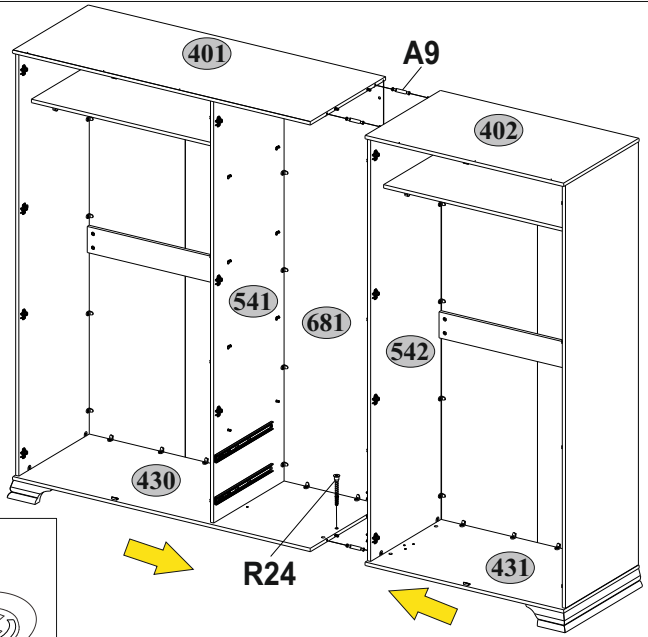
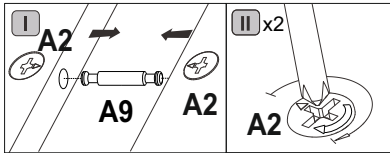
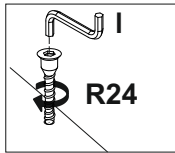

20

R27

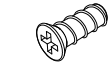

5,0x13

5

S12



5

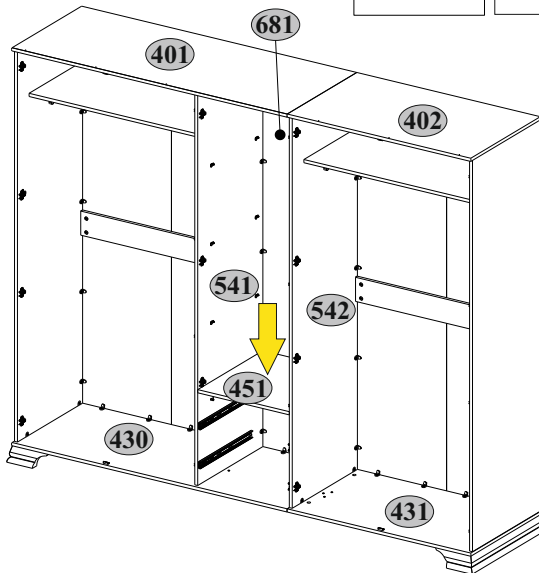
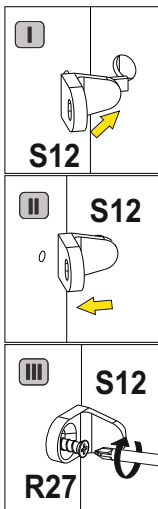
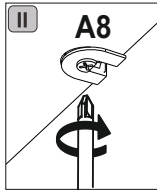
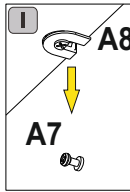

21**x2****A1.0**

5x28

8

A2

15x13

8

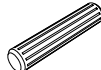
C1

8x35

8

H18

2

M1

M4x12

4

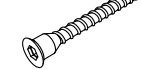
R24

7x50

8

R27

5,0x13

12

S5

Ø18

8

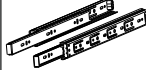
Z13

450

2

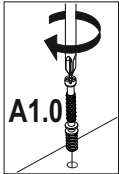
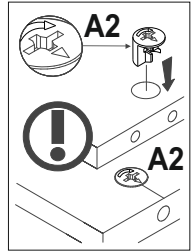
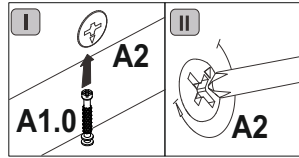
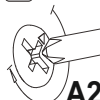
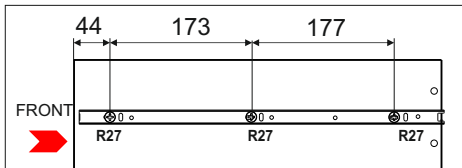
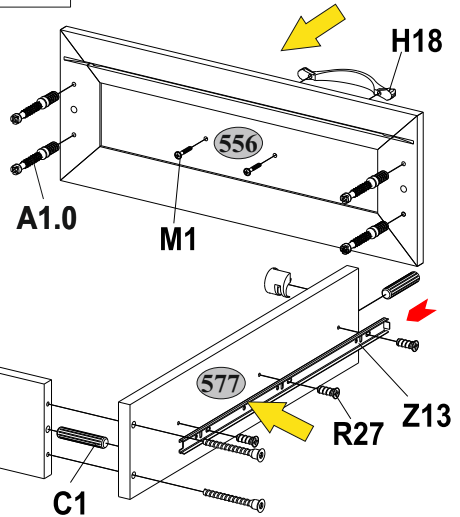
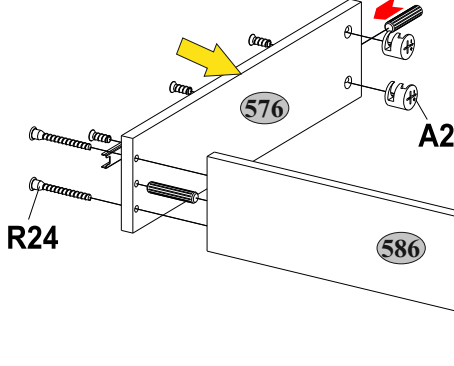
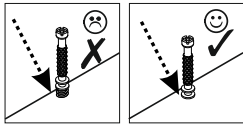
**A1.0****I****A1.0****A2****II****A2**

FRONT

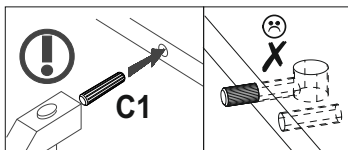
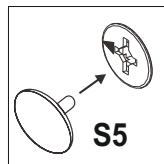
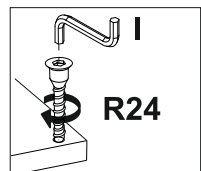
**R27****R27****R27****C1****S5****R24**

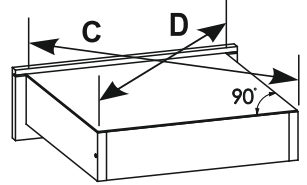
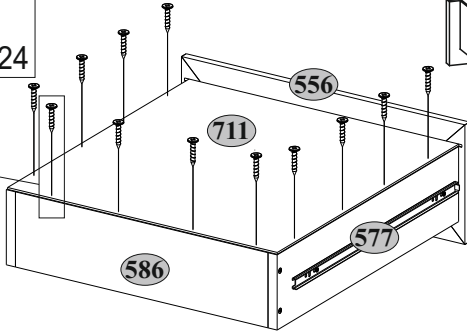
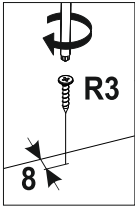
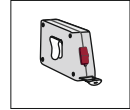
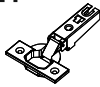
22**x2****R3****C=D****23****E1**

16

E4**H18**

5

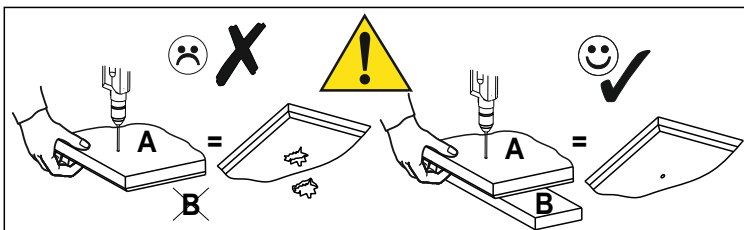
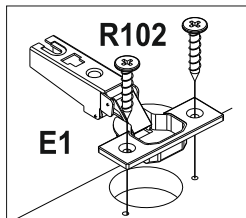
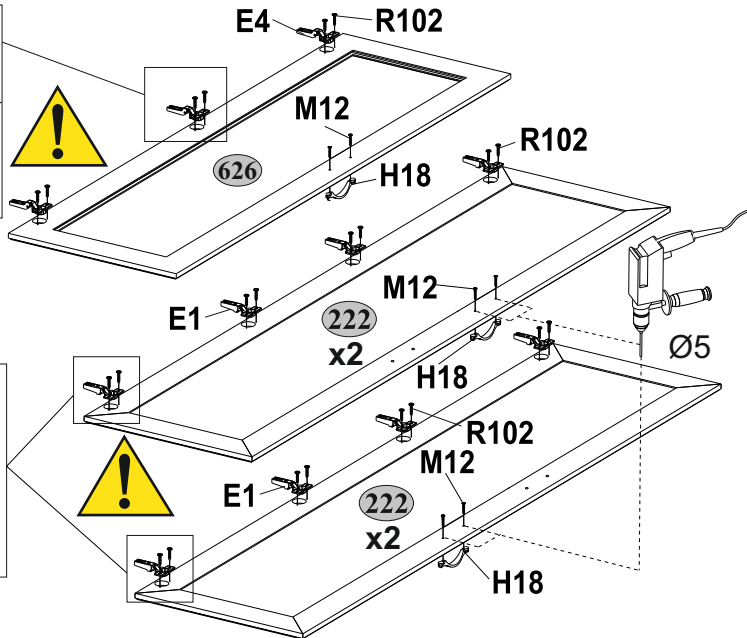
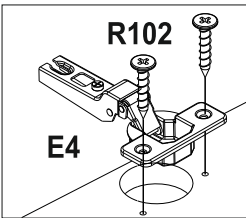
M12**R102**

24

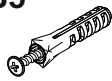
B5

 10x50 3

Q

 10

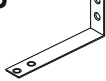
R102

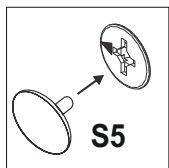
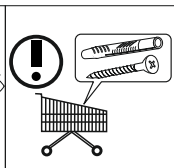
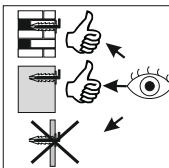
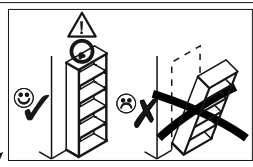
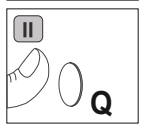
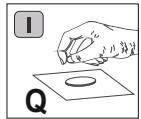
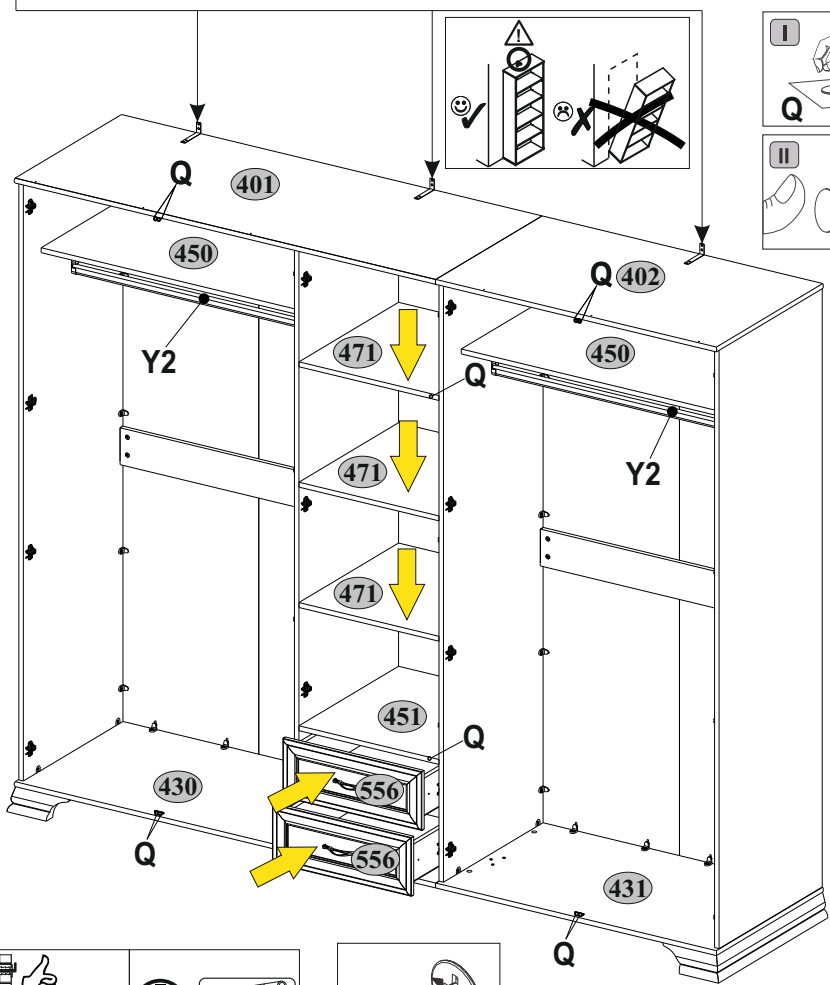
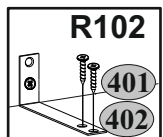
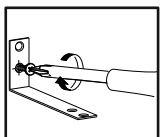
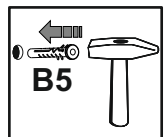
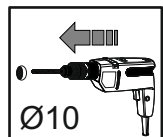
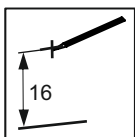
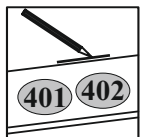
 3,5x16 6

S5

 Ø18 14

U

 90x35x15 3



450 451 471 556

 max. 5 kg

Y2 430 431

 max. 10 kg

25

R30

2,9x9,5



8

R39

3,5x25



10

U6

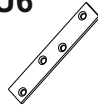

1

U8

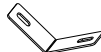

120°

2

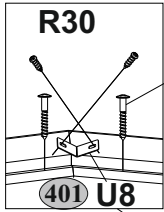

R39



666

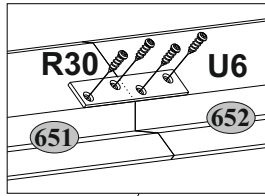

R30

U6

651

652

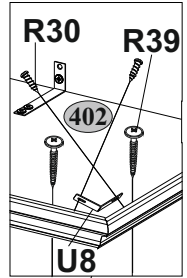

R30

R39

402

U8

